



Jaroslav Rzepka MERCOS - Boleslavova 4, 709 00 Ostrava 9, Czech Republic

tel / fax : +420 596 627 097 , tel : +420 596 616 729 , mob : +420 602 800 007
email : mercosp@mercosp.cz , www : <http://www.mercosp.cz>

PROCESS INSTRUMENT INSTRUCTIONS MANUAL

DCP 01

UP / DOWN COUNTER

A	BASIC PREVIEW OF MENU ADDRESSES AND SUB-ADDRESSES	PAGE 1 – 2
B	DETAIL DESCRIPTION OF EACH ADDRESS FUNCTION	PAGE 2 – 4
C	DETAIL DESCRIPTION OF BUTTONS USAGE	PAGE 5
D	SAFETY OPERATIONS	PAGE 6

A. BASIC PREVIEW OF MENU ADDRESSES AND SUB-ADDRESSES

Address	Description	Sub-addresses
A_00	Multiplication or division selection for input impulse signal (<i>see more A_02</i>)	0 : division (eg. 5 imp. = 1 digit) 1 : multiplication (eg.: 1 imp=5 digits)
A_01	SELECTION of input impulse signal type <u>descending edge</u> : from log. "1" to log. "0" <u>rising edge</u> : from log. "0" to log. "1"	0 : indirect reaction on descending edge 1 : direct reaction on rising edge
A_02	Multiplication or division constant	adjustable from 1 to 199
A_03	SELECTION of UP or DOWN counting (<i>down counting see more A_07</i>)	0 : UP counting 1 : DOWN counting
A_04	Counted value and counted value overflow RESET 1 overflow = 1000000 digits	ANO = Yes , NE = No
A_05	DECIMAL POINT	
A_06	DISPLAY counted value overflow(s)	Max no. of overflows is 9999
A_07	SETUP of presetted value for counting DOWN function	0 – 999 999
A_08	ACCESS to RESET of counted value & counted value overflow * <i>If sub-address 1 on A_03 is selected, RESET function will set the PRESETED value from A_07 not clear display to 000000.</i>	0 : only from menu (reset and setup of presetted value is accessible in menu only) 1 : directly from main display and menu (reset and setup of presetted value is accessible both from menu and main display)
A_09	Valid INPUT signal pulse duration selection	0.1 – 999.9 ms
A_10	LED display BRIGHTNESS	0 : 100% 1 : 50%
A_11	Settings of EXTERNAL RESET reaction type	0 : reaction to the logic level 1 : reaction to edge
RESET from main display	<p>A. "UP" Counter : step 1 : in main display we will use button no.1 (main display list) to switch from counted value display (eg.: 3512) to second display : "- - - - -" (symbol for RESET) . step 2 : once is "- - - - -" displayed, we press button no.3 (Enter) to confirm RESET function. Counted value and counted value overflow(s) is now reseted. Device will return itself to counted value display in approx. 2-4 seconds.</p> <p>B. "DOWN" Counter : step 1 : in main display we will will use button no.1 (main display list) to switch from counted value display (eg.: 3512) to second display : "- - - - -" (symbol for RESET) . step 2 : once is "- - - - -" displayed, we press button no.3 (Enter) to confirm RESET function. Counted value will be set to presetted value (A_07). Device will return itself to counted value display in approx. 2-4 seconds.</p> <p>If we do not want to execute RESET function, we can wait approx. 2-4 secs till device will return to counted value display. Or switch manually to counted value display by button no.1 .</p>	
PRESET from main display	<p>ONLY valid in DOWN counter mode step 1 : in main display we will use button no.1 (main display list) to switch from counted value display (eg.: 3512) to "Set UP" (symbol for PRESET value). step 2 : we press button no.3 to enter PRESET value setup. Now we are redirected to A_07 address and we can change the value and confirm changed value, "hotouo" will be displayed to confirm successful operation and by button no.4 (ESC) we will return back. If we do not want to change PRESET value, we can wait approx. 2-4 secs till device will return to counted value display. Or switch manually to counted value display by button no.1 . If we entered PRESET value and change it, we can still exit without saving the changed value by button no.4 (ESC)</p>	

A_14	Set limit L1 in main display **)	0 : disabled 1 : enabled
A_15	Limit L1 numeral setting	in full range of scale
A_16	MEMORY function for relay Re1	0 : without memory function 1 : with memory function
A_17	Limit L1 Hysteresis timing	from 0 to 299.9 s, step: 0.1 s
A_18	L1 relay output function: direct: relay closes, inverted: relay opens	0 : inverted 1 : direct
A_19	Set limit L2 in main display **)	0 : disabled 1 : enabled
A_20	Limit L2 numeral setting	in full range of scale
A_21	MEMORY function for relay Re2	0 : without memory function 1 : with memory function
A_22	Limit L2 Hysteresis timing	from 0 to 299.9 s, step: 0.1 s
A_23	L2 relay output function: direct: relay closes, inverted: relay opens	0 : inverted 1 : direct
A_24	Output signal TYPE selection	0 : 0 – 20 mA DC 1 : 4 – 20 mA DC 2 : 0 – 10 V DC
A_25	Analogue output scale beginning assignment	eg.: 0 digits (4 mA)
A_26	Analogue output scale end assignment	eg.: 1000 digits (20mA)
A_27	Correction for COUNTED VALUE	- 29 999 to + 29 999 digits
NOTICE: *) enabling this feature provides access to RESET of counted value and counted value overflow(s) and PRESET value without password protection ! **) enabling this feature provides full access to the value of limits without password protection !		

B. DETAIL DESCRIPTION OF EACH ADDRESS FUNCTION





Address	Description
A_00	Multiplication or division selection for input impulse signal - by setting sub-address 0 at A_00, counter will count specified number of impulses (set on address A_02) before it increase or decrease counted value by one digit. /eg.: 10 impulses = 1 digit/ - by setting sub-address 1 at A_01, counter will increase or decrease counted value by specified number of digits (A_02) on each valid impulse. /eg.: 1 impulse = 10 digits/ For normal 1 impulse = 1 digit counting , set 1 to A_00 and 1 to A_02.
A_01	SELECTION of input impulse signal type - direct or indirect If sub-address 1 on A_01 is selected, counter reacts on rising edge (transition from log. 0 to log. 1). If sub-address 0 on A_01 is selected, counter reacts on descending edge (transition from log. 1 to log. 0). See more on A_09 description!
A_02	Multiplication or division constant 3 input impulses counted as 1 digit on display. We set 0 to A_00 and 3 on A_02. Division 1 input impulse counted as 10 digits on display. We set 1 to A_00 and 10 on A_02. Multiplication

A_04	Counted value and counted value overflow RESET This address contains dialogue "ANO NE", which is asking user to confirm RESET function. Symbol "ANO" is yes and symbol "NE" is no. First character is blinking to show which selection is active.
A_05	position of Decimal Point - DP (changing by button no.2) - DP position is used for limits, presetted value, analogue output - for ex.: input signal has a scale 0 - 4.000 -> DP is set to x x x . x x x
A_06	DISPLAY counted value overflow(s) - if counted value is greater than 999999, counter automatically increase counted value overflow and start to count from zero (respecting the remainder in case of multiplication function). Counted value overflow is stored up to 9999 overflows and can be viewed on A_06. It is reseted together with counted value.
A_07	SETUP of presetted value for counting DOWN function - decimal point is displayed
A_08	ACCESS to RESET the counted value & counted value overflow(s) <i>enabling this fetature privides access to RESET of counted value and counted value overflow(s) and PRESET value without password protection !</i>
A_09	Valid INPUT signal pulse duration selection Nastavený čas znamená: - impuls je platný, je-li čas > než nastavená hodnota a zároveň - doba po impulsu je > než nastavená hodnota To provide safe impulse response is recommended to set length of valid input impulse : - 50 Hz max. 3.5 ms - 100 Hz max. 2.0 ms - 200 Hz max. 1.0 ms - 500 Hz max. 0.5 ms - 800 Hz max. 0.1 ms - 1000 Hz max. 0.0 ms <i>If logical level will not be held for time entered on address A_09, counter will not recognize this as a valid impulse. Please notice that each logical level has to be valid for time specified on address A_09. Impulse signal has NOT to be symetrical.</i>
A_10	level of LED display BRIGHTNESS - 0 means 100% BRIGHTNESS and 1 means 50% BRIGHTNESS
A_11	sub-address 0 (on logical level) , on transition from log. 0 to log. 1 is executed RESET function and until the log. 1 continous, counting is not started. After transition form log.1 to log. 0 is counting started. sub-address 1 (on edge) , if transition from log. 0 to log. 1 appears RESET function is executed and counting is immediatelly started.
A_14	Set limit L1 in main display 0 - no direct access of L1 in main display , 1 - direct access L1 in main display this selection enables setting of limit L1 in main display, instead of entering menu (by typeing password) and accessing the address 15. You can simply list L1 in main display (by button no. 1) and by pressing enter button you can setup the value of limit L1.
A_15	Limit L1 numeral setting - when the measured value reach the L1, relay RE1 will open/close(see address 18) - the value of L1 could be set in full range of display (0 – 999999)
A_16	sub-address 0 (without memory function) if counted value reach L1 value, relay is open/close (dependes on A_18) and with regard to time hysteresis dtL1. sub-address 1 (with memory function) if counted value reach L1 value, relay is open/close (dependes on A_18) and with regard to time hysteresis dtL1. Relay is continously opened/closed till RESET function is executed. Relay ignores changes of limit value on address A_15.

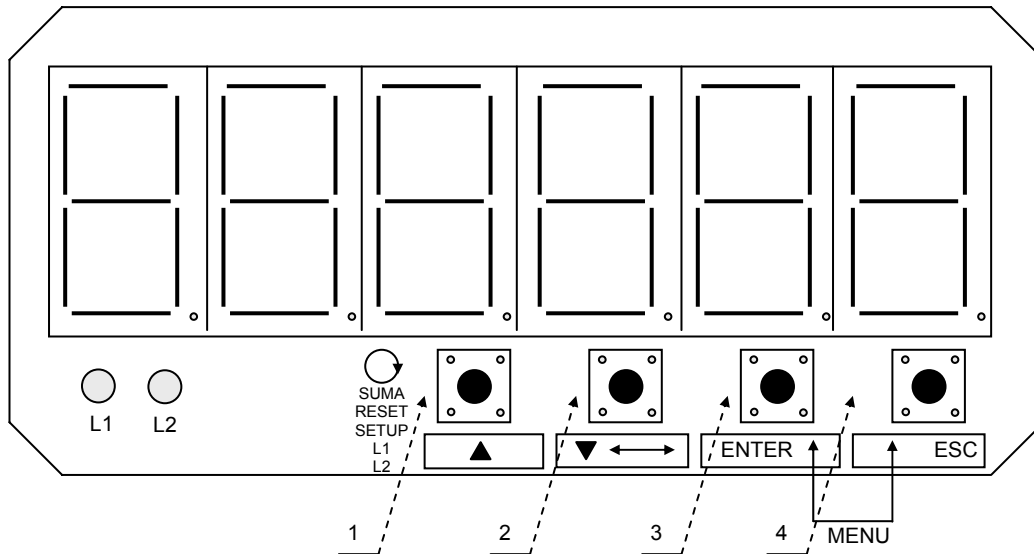
A_17	<p>Limit L1 HYSTERESIS timing: dtL1</p> <ul style="list-style-type: none"> - this address provides limit L1 HYSTERESIS timing - the value of dtL1 could be set from 0 to 299.9 s (step: 0.1 s) - description: if the input signal reach the value of L1, relay closes/opens (see address 18) after the time of dtL1 countdown. (from 0s to 299,9s) - if the input signal overloads the value of L1, dtL1 count down is activated. If the input signal falls under the value of L1 during the dtL1 count down is timing, the relay RE1 will not be activated and the dtL1 count down timing is reseted.
A_18	<p>Selection of function RE1 when the measured value reach limit L1 :</p> <ul style="list-style-type: none"> - direct function: when relay RE1 reach L1 opens /the hook contact of RE1 is activated/ - indirect function : when relay RE1 reach L1 closes /the unhook contact of RE1 is activated/
A_19	<p>Set limit L2 in main display</p> <p>0 - no direct access of L2 in main display , 1 - direct access L2 in main display</p> <p>this selection enables setting of limit L2 in main display, instead of entering menu (by typeing password) and accessing the address 20. You can simply list L2 in main display (by button no. 1) and by pressing enter button you can setup the value of limit L2.</p>
A_20	<p>Limit L2 numeral setting</p> <ul style="list-style-type: none"> - when the measured value reach the L2,relay RE2 will open/close(see address 18) - the value of L2 could be set in full range of display (0 – 999999)
A_21	<p>sub-address 0 (without memory function)</p> <p>if counted value reach L2 value, relay is open/close (dependes on A_22) and with regard to time hysteresis dtL2.</p> <p>sub-address 1 (with memory function)</p> <p>if counted value reach L2 value, relay is open/close (dependes on A_22) and with regard to time hysteresis dtL1. Relay is continously opened/closed till RESET function is executed. Relay ignores changes of limit value on address A_20.</p>
A_22	<p>Limit L2 HYSTERESIS timing: dtL2</p> <ul style="list-style-type: none"> - this address provides limit L2 HYSTERESIS timing - the value of dtL2 could be set from 0 to 299.9 s (step: 0.1 s) - description: if the input signal reach the value of L2, relay closes/opens (see address 23) after the time of dtL2 countdown. (from 0s to 299,9s) - if the input signal overloads the value of L2, dtL2 count down is activated. If the input signal falls under the value of L2 during the dtL2 count down is timing, the relay RE2 will not be activated and the dtL2 count down timing is reseted.
A_23	<p>Selection of function RE2 when the measured value reach limit L2 :</p> <ul style="list-style-type: none"> - direct function: when relay RE2 reach L2 opens /the hook contact of RE2 is activated/ - indirect function : when relay RE2 reach L2 closes /the unhook contact of RE2 is activated/
A_24	<p>Type of output signal</p> <ul style="list-style-type: none"> - selection of input signal: 0-20 mA, 4-20 mA, 0-10 VDC and user defined output signal in range 0..22 mA & 0..11V DC
A_25	<p>Analogue output scale beginning assignment</p> <ul style="list-style-type: none"> - beginning of scale range, which is assigned to beginning of analogue output - eg.: output signal 0-20 mA (0 on A_24) is assigned to 0 digit. So the output signal 0mA represents 0 digit.
A_26	<p>Analogue output scale end assignment</p> <ul style="list-style-type: none"> - end of scale range, which is assigned to end of analogue output - eg.: output signal 0-20 mA (0 on A_24) is assigned to 2000 digits. So the output signal 20mA represents 2000digits.
A_27	<p>Correction for counted value</p> <p>For optical correction of counted value user can set correction value. Counted value is stored at different location, so if correction is set to zero value – user will get true counted value.</p>

C. DETAIL DESCRIPTION OF BUTTONS USAGE

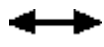

1	 <p>SUMA RESET SETUP L1 L2</p>	<p>1. funkce: provides listing in main display: Counted value , RESET and SETUP (preset)</p> <p>Main display switch by pressing button as follows: - Counted value : is shown on power-on, or return to it from other display if no button is pressed for approx. 2 – 4 secs. - RESET: represented by " - - - - - " symbol. See more in section A, RESET from main display. - SETUP: represented by "SEt UP" symbol. See more in section A, PRESET from main display.</p> <p>- limit L1: symbol ' L1 ' is shown for less than 10 s and then if no button pressed returns to the counted value, if enter button is pressed the value of limit will be shown. By pressing enter button again, you will access setting value of limit L1. - limit L2: same as limit L1 Then the set of L1, L2 is standart as a normal access to the L1, L2 from the menu. Anytime you can exit by pressing ESC button without changes. * displayed symbols L1, L2 depends on actual configuration of process meter and on settings on addresses A_14, A19.</p>
		<p>2. function: in programming state this button provides increasing the value on the selected digit of display. (xxx(x)xx highlited 'x' is blinking and button ^ increase value): - to setup numeral data in basic addresses : A_01 - A_53 (see notice below) - to setup the selection in SUB-ADRESSES - to setup all numeral values (eg. L1, L2 etc...)</p>
2		<p>1. function: in programming state this button provides switching the highlighted (blinking) digit on display (eg. xxx(x)xx, <-> , xxx(x)x , <-> , xxx(x)x , <-> (x)xxxxx) - valid only for setup in addresses where is the numeral value setuped. - not valid for setting SUB-ADRESSES switches / "program switches" / (for ex.: A_00, A_01)</p>
		<p>2. function: in menu this button provides decreasing numeral value of address A_00 - A_26 . (eg.: A_15 → button pressed → A_14 → button pressed → A_13) notice: if you press the button and the numeral value of adress is 0 (A_00) the next value will be 26 (A_26) -> cycle</p>
3+4	<p>ENTER + ESC</p>	<p>pressing together button "ENTER" and "ESC" provides entering to the password protected menu. - by pressing ENTER+ESC together, on display appears " 0 0 0 0 " and device is waiting for the password. (if no button pressed in 5 second the device returns back) - user password : provides access to the address A_00 - A_53 ('user setup area') - with buttons n.1 and n.2 write the password and then confirm by pressing ENTER button. notice: the password cannot be change so be careful and hide the password from any unauthorized person</p>
3	<p>ENTER</p>	<p>ENTER provides confirm and saving values - by confirm (pressing ENTER butt) address (eg.: A_02) you enter the programming state - now you can set the value or exit by pressing ESC button. - by next pressing ENTER the setuped value is saved into EEPROM memory and on display appears message 'hotouo' - Confirm this message by pressing ESC button</p>
4	<p>ESC</p>	<p>ESC provides escaping the programing state , menu , etc...</p>

D. SAFETY OPERATIONS

1. SETTING IN OPERATION

Device doesn't require any before running procedures and is ready to use after unpacking. Make sure that proper supply voltage is set and all input and outputs are connected correctly before connection to supply system.

Device is factory pre-seted, if no other specifications were received: *)

L1= 10 L2= 12 UP counter

Analogue output: 4 – 20 mA

*) available functions may vary due to device configuration

Electrical wiring has to be done by skilled person, device setup can be done by instructed person.

2. TERMINAL STRIP

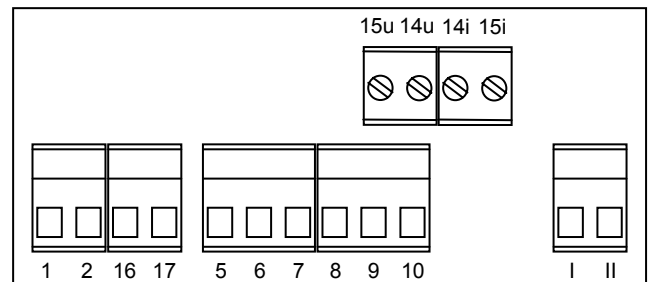
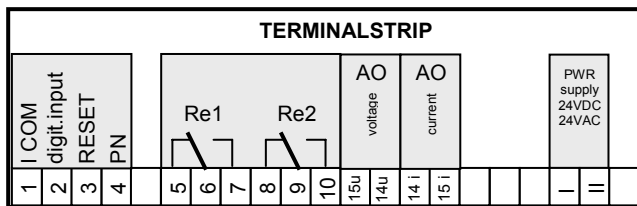

3. EXCITATION SUPPLY WIRING

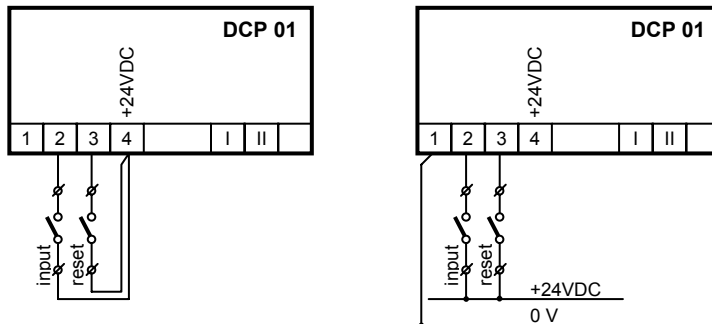

4. INSTALLATION AND MAINTAINANCE INSTRUCTIONS

Instrument is continuous run device and doesn't have own power-off switch. Installation must contain some power-off switch or building distribution circuit-breaker (e.g. power-off switch in switchboard or main distribution circuit-breaker). It has to be easily accessible by operating staff and has to be marked as cutting-off element.

DCP01 is constructed to require minimal maintenance. Front panel with foil keypad isn't resistant to organic solvents (e.g. toluene, acetone etc...)

Use only suitable non-aggressive cleaners for cleaning front panel (e.g. industrial alcohol).

To prevent long-term failure-free operation, it is recommended to use the device in the specified temperature range, not expose to extreme climatic conditions, which have an effect on the lifetime of electronic components.

5. REPAIR INSTRUCTIONS

Each device was subjected to components quality check control, pre-setting circuits and 24 hours burn-in on power supply. After 24 hours burn-in, a pre-set parameters check was made. If device failure occurs (e.g. by overvoltage, mechanical damage, device malfunction ...), that impacts its own functionality, it is necessary to contact the manufacturer, which will provide appropriate repair.

6. WARRANTY

The manufacturer guarantees in accordance with §429 Commercial code (Czech Republic) for technical and operating characteristics, specified in the accompanying technical documentation. The device has a 36-month warranty and after warranty service is provided. This warranty does not apply: (a) to damage caused by accident, abuse, misuse, misapplication; (b) to unauthorized repair or modification or (c) if the serial number has been removed or defaced.